

LIST PRICING &
PRODUCT SPECIFICATIONS
Effective July 2023



WOLF HOME PRODUCTS®

CABINETS

BUILDERS MARK™
FROM WOLF HOME PRODUCTS®

TEMPO

BUILDERS MARK TEMPO FROM WOLF HOME PRODUCTS

The Budget-Friendly Choice

Whether you're creating a large decorative space or building a small galley kitchen, when you choose Builders Mark Tempo cabinets your imagination won't be limited — even if your budget is.

Exceptional Value

Builders Mark Tempo cabinets feature quality wood doors and face frames and come with 1/2" shelves, 6-way adjustable, fully concealed, self-closing hinges and an easy-clean interior. Plus, you can choose from a variety of smart storage solutions as well as functional and decorative accessories to make any size project your own.

Buy with Confidence

You can be confident when buying Builders Mark Tempo cabinets. In addition to certifications from the Kitchen Cabinet Manufacturers Association (KCMA), Builders Mark Tempo comes with a 2-year limited warranty.

PRODUCT CHARACTERISTICS

Natural Beauty of Wood

Wood is a natural product with variations in grain, texture and color. As a result of natural conditions, some species will develop characteristics such as burls, pecks, pin burls, shakes, split knots and mineral streaks to name a few. In some instances, even the color will vary greatly within a single piece of wood or cabinet component. A certain amount of variations is allowed and, in fact, is desirable. Doors with these types of characteristics are not to be considered defective. Natural and light finishes will not cover any naturally occurring variation. In addition, all wood will age overtime deepening or mellowing its tone. These characteristics are not to be misinterpreted as defects. Wood is a product of nature- and as such will display natural characteristics and variances that are unique to each and every cut. These characteristics are an integral part of the charm and beauty of real wood.

Finish Process

1. All surfaces are machine-sanded.
2. Dust particles are removed before entering each spray machine.
3. Product enters an automated finish system where solvent-based pigment stain is applied.
4. Product is sealed and put through a pre-cure drying process.
5. Complete cure is done with slow bake process.
6. All edges of parts are hand-sanded before being put in a brush-sanding machine.
7. Final topcoat is applied and put through a pre-cure process followed by slow bake for final, thorough curing.
8. Clear finishes use a catalyzed varnish, and paint finishes use a post-catalyzed lacquer.
9. Products are inspected for defects, cleanliness and smoothness.
10. The front side of the products gets a stain coat, a sealer coat and final top coat. The backs of drawer fronts and doors get a stain coat and a sealer coat

DOOR INFORMATION

SAWYER STAIN

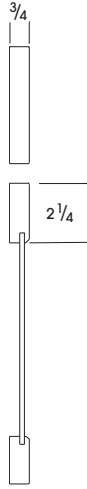

Dark Sable (B01)



Grey (B02)

- **Standard Overlay**
- One-piece Drawer Front
- Flat Panel Door
- Maple with Veneer Center Panel - Stain

SAWYER PAINT

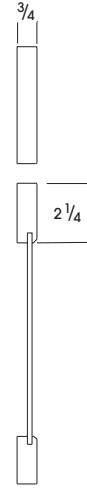

Pewter (B03)



White (B04)

- **Standard Overlay**
- One-piece Drawer Front
- Flat Panel Door
- HDF with MDF Center Panel - Paint

CABINET SPECIFICATIONS

Face Frame	3/4" thick x 1 1/2" wide solid wood face frame
Side Panels	3/8" thick furniture board with color matching exterior
Back Panel	3/8" thick furniture board
Top/Bottom	3/8" thick furniture board
Interior	Natural maple interior - Stained finishes - Pewter Paint
	White interior - White paint
Shelves	Bull-nosed, foil covered front edge
	1/2" thick MDF, adjustable, with locking shelf clip
Corner Blocks	Plastic
Hanging Rail	3/8" thick furniture board
Drawers	Dovetail - bull-nosed, foil covered top edges
	1/2" thick MDF front, back, and sides
	1/8" thick MDF, captured bottom
Glides	Side mounted white epoxy glides; 3/4 extension 75 lb. weight capacity
Hinges	Self Closing, 6-way adjustable

Standard Overlay

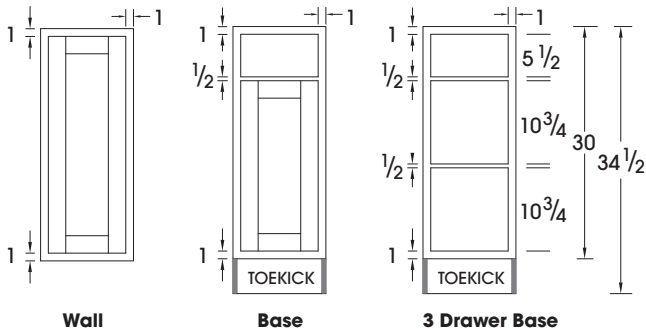

Wall Cabinets – 12" Deep

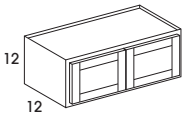
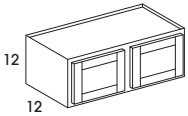
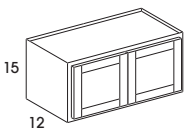
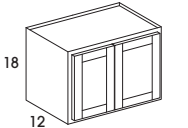
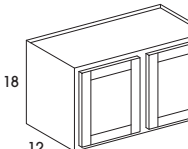
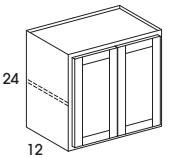
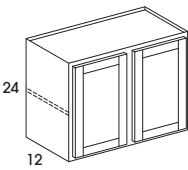
In Stock SKUs		SKU's	cubes	Sawyer Stain/Paint
WALL - 12" HIGH - 12" DEEP				
 <p>12 12</p>	<ul style="list-style-type: none"> • Two butt doors • Shelves not available • Available widths 30"-36" 	W3012	4.0	265
		W3312	4.0	277
		W3612	5.0	298
 <p>12 12</p>	<ul style="list-style-type: none"> • Two doors with center mullion • Shelves not available • Available width: 39" 	W3912	6.0	320
WALL - 15" HIGH - 12" DEEP				
 <p>15 12</p>	<ul style="list-style-type: none"> • Two butt doors • Shelves not available • Available widths 30"-36" 	W3015	4.0	265
		W3315	5.0	277
		W3615	6.0	298
WALL - 18" HIGH - 12" DEEP				
 <p>18 12</p>	<ul style="list-style-type: none"> • Two butt doors • Shelves not available • Available widths: 24"-36" 	W2418DD	4.0	245
		W3018	5.0	265
		W3318	6.0	277
		W3618	6.0	298
 <p>18 12</p>	<ul style="list-style-type: none"> • Two doors with center mullion • Shelves not available • Available width: 39" 	W3918	7.0	370
WALL - 24" HIGH - 12" DEEP				
 <p>24 12</p>	<ul style="list-style-type: none"> • Two butt doors • One adjustable shelf • Available widths: 24"-36" 	W2424DD	5.0	325
		W3024	7.0	355
		W3324	7.0	298
		W3624	8.0	422
 <p>24 12</p>	<ul style="list-style-type: none"> • Two doors with center mullion • One adjustable shelf • Available width: 39" 	W3924	9.0	395

Wall Cabinets – 12" Deep

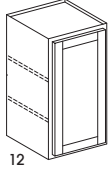
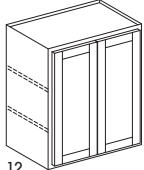
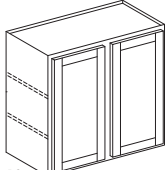
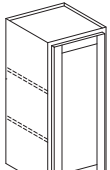
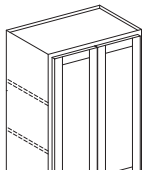
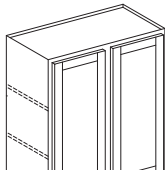
In Stock SKUs		SKU's	cubes	Sawyer Stain/Paint
WALL – 30" HIGH – 12" DEEP				
 <p>30 12</p>	<ul style="list-style-type: none"> • Single door - hinged left • Cabinet can be flipped during installation for right hinge applications • Two adjustable shelves • Available widths: 9"-21" 	W0930	3.0	228
		W1230	4.0	246
		W1530	5.0	250
		W1830	5.0	255
		W2130	6.0	294
 <p>30 12</p>	<ul style="list-style-type: none"> • Two butt doors • Two adjustable shelves • Available widths: 24"-36" 	W2430DD	7.0	334
		W2730	7.0	348
		W3030	8.0	420
		W3330	9.0	430
		W3630	10.0	440
 <p>30 12</p>	<ul style="list-style-type: none"> • Two doors with center mullion • Two adjustable shelves • Available widths: 39"-45" 	W3930	10.0	460
		W4230	11.0	468
		W4530	11.0	496
WALL – 36" HIGH – 12" DEEP				
 <p>36 12</p>	<ul style="list-style-type: none"> • Single door - hinged left • Cabinet can be flipped during installation for right hinge applications • Two adjustable shelves • Available widths: 9"-21" 	W0936	4.0	263
		W1236	5.0	279
		W1536	6.0	291
		W1836	6.0	296
		W2136	7.0	336
 <p>36 12</p>	<ul style="list-style-type: none"> • Two butt doors • Two adjustable shelves • Available widths: 24"-36" 	W2436DD	8.0	400
		W2736	8.0	420
		W3036	9.0	450
		W3336	10.0	460
		W3636	10.0	480
 <p>36 12</p>	<ul style="list-style-type: none"> • Two doors with center mullion • Two adjustable shelves • Available widths: 39" and 42" 	W3936	11.0	495
		W4236	12.0	516

Wall Cabinets – 12", 15", and 24" Deep

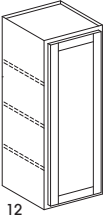
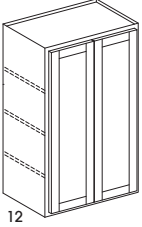
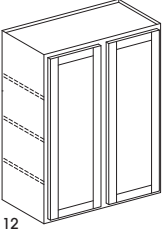
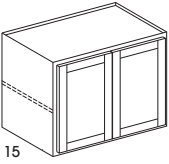
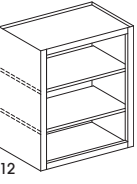
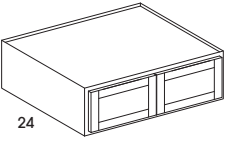
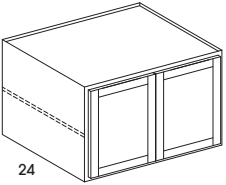
In Stock SKUs		SKU's	cubes	Sawyer Stain/Paint
WALL – 42" HIGH – 12" DEEP				
 <p>42 12</p>	<ul style="list-style-type: none"> • Single door - hinged left • Cabinet can be flipped during installation for right hinge applications • Three adjustable shelves • Available widths: 9"-21" 	W0942	4.0	291
		W1242	4.0	308
		W1542	5.0	315
		W1842	6.0	325
		W2142	7.0	370
 <p>42 12</p>	<ul style="list-style-type: none"> • Two butt doors • Three adjustable shelves • Available widths: 24"-36" 	W2442DD	8.0	400
		W2742	8.0	440
		W3042	10.0	472
		W3342	10.0	482
		W3642	11.0	500
 <p>42 12</p>	<ul style="list-style-type: none"> • Two doors with center mullion • Three adjustable shelves • Available widths: 39"-42" 	W3942	11.0	545
		W4242	12.0	590
WALL – 24" HIGH – 15" DEEP				
 <p>24 15</p>	<ul style="list-style-type: none"> • Two butt doors • One adjustable shelf • Available width: 30" 	W302415	8.0	475
BOOKCASE CABINET – 30" HIGH – 12" DEEP				
 <p>30 12</p>	<ul style="list-style-type: none"> • No door • Matching Interior • Two adjustable shelves • Available widths: 18" and 24" 	BK1830	5.0	420
		BK2430	7.0	565
REFRIGERATOR WALL – 24" DEEP				
 <p>12 18 24</p>	<ul style="list-style-type: none"> • Two butt doors • Shelves not available • Available heights: 12" and 18" • Available width: 36" 	RW3612	6.0	381
		RW3618	10.0	391
 <p>24 24</p>	<ul style="list-style-type: none"> • Two butt doors • One adjustable shelf • Available height: 24" • Available width: 36" 	RW3624	12.0	452

Wall Cabinets – 12" Deep

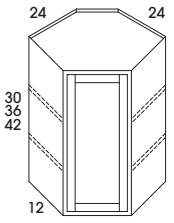
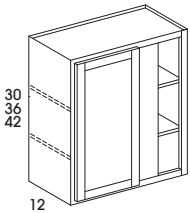
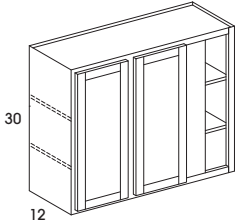
In Stock SKUs	SKU's	cubes	Sawyer Stain/Paint
WALL CORNER - DIAGONAL			
 <ul style="list-style-type: none"> • Single door - hinged left • Cabinet can be flipped during installation for right hinge applications • 30" and 36" have two adjustable shelves • 42" has three adjustable shelves • Available width: 24" 	WDC2430	13.0	463
	WDC2436	15.0	606
	WDC2442	16.0	724
WALL CORNER - BLIND - 12" DEEP			
 <ul style="list-style-type: none"> • Single door - hinged left • Cabinet can be flipped during installation for right hinge applications • 30" and 36" have two adjustable shelves • 42" has three adjustable shelves • Blind cabinets can be pulled 3" • Blind opening is 7" on all sizes • Does not include a panel to cover blind opening • Filler required; order separately • Available widths: 30" and 36" 	WC3030	8.0	360
	WC3630	9.0	397
	WC3036	9.0	475
	WC3636	10.0	485
	WC3042	10.0	510
	WC3642	11.0	520
 <ul style="list-style-type: none"> • Two doors with center mullion • Two adjustable shelves • Blind cabinets can be pulled 3" • Blind opening is 7" on all sizes • Does not include a panel to cover blind opening • Filler required; order separately • Available widths: 42" 	WC4230	10.0	431

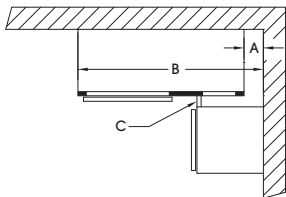

SKU	Cabinet Width	Blind Opening	Center Stile	A		B		C
				Minimum	Maximum	Minimum	Maximum	Minimum Filler width
WC30_ _	30"	7"	6"	0"	3 1/2"	30"	33 1/2"	N/A
WC36_ _	36"					36"	39 1/2"	
WC42_ _	42"					42"	45 1/2"	

A = Pull distance from wall
 B = Cabinet distance from wall
 C = Minimum filler width

Note: Blind openings are right side: cabinet will be flipped during installation for left blind applications.

Base Cabinets – 24" Deep

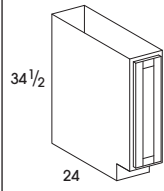
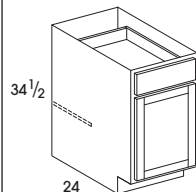
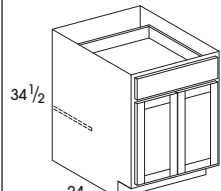
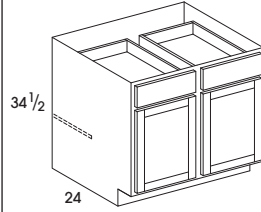
In Stock SKUs	SKU's	cubes	Sawyer Stain/Paint
BASE - 34 1/2" HIGH - 24" DEEP			
 <ul style="list-style-type: none"> • Single full-height door - hinged left • Door can be reversed during installation for right hinge applications • Available width: 9" 	B09FH	6.0	336
 <ul style="list-style-type: none"> • Single door - hinged left • Door can be reversed during installation for right hinge applications • One drawer • One adjustable half-depth shelf • Available widths: 12"-21" 	B12	7.0	348
	B15	9.0	357
	B18	10.0	383
	B21	12.0	397
 <ul style="list-style-type: none"> • Two butt doors • One drawer • One adjustable half-depth shelf • Available widths: 24"-36" 	B24DD	13.0	440
	B27	15.0	449
	B30	17.0	465
	B33	18.0	490
	B36	20.0	518
 <ul style="list-style-type: none"> • Two doors with center mullion • Two drawers • One adjustable half-depth shelf • Available widths: 39"-48" 	B39	21.0	594
	B42	23.0	680
	B48	23.0	845

Base Cabinets – 24" Deep

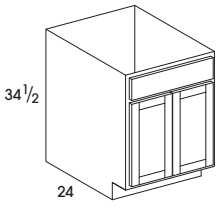
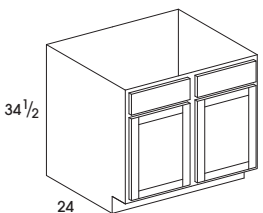
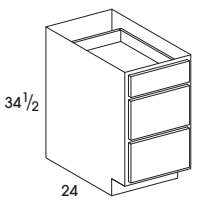
In Stock SKUs		SKU's	cubes	Sawyer Stain/Paint
SINK BASE - 34 1/2" HIGH - 24" DEEP				
 <p>34 1/2 24</p> <ul style="list-style-type: none"> • Two butt doors • One false panel • Available widths: 24"-36" 		SB24DD	14.0	415
		SB27	16.0	426
		SB30	18.0	431
		SB33	19.0	442
		SB36	20.0	469
 <p>34 1/2 24</p> <ul style="list-style-type: none"> • Two doors with center mullion • Two false panels • Available widths: 39"-48" 		SB39	22.0	480
		SB42	23.0	502
		SB48	23.0	546
THREE DRAWER BASE - 34 1/2" HIGH - 24" DEEP				
 <p>34 1/2 24</p> <ul style="list-style-type: none"> • Three drawers • Available widths: 12-36" 		DB12D3	7.0	468
		DB15D3	9.0	479
		DB18D3	10.0	515
		DB21D3	12.0	540
		DB24D3	13.0	573
		DB30D3	17.0	673
		DB36D3	20.0	701

Base Cabinets – 24" Deep

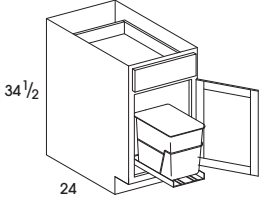
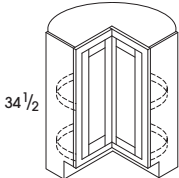
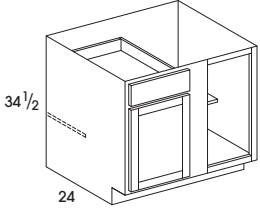
In Stock SKUs		SKU's	cubes	Sawyer Stain/Paint
BASE WASTEBASKET CABINET - 34 1/2" HIGH - 24" DEEP				
	<ul style="list-style-type: none"> • Bottom mounted wastebasket • Includes one white 30qt trash can • Available width: 18" 	BWB18	10.0	714
BASE CORNER LAZY SUSAN - 34 1/2" HIGH				
	<ul style="list-style-type: none"> • Doors are attached to shelf and rotate with the shelves • Floor space required: 36" x 36" • 24" diameter lazy susan • Available width: 36" 	LS36	30.0	705
BASE CORNER - 34 1/2" HIGH - 24" DEEP				
	<ul style="list-style-type: none"> • Single door - hinged left • Door can be reversed during installation for right hinge applications • One drawer • One adjustable half-depth shelf • Does not include a panel to cover blind opening • Filler required; order separately • Available width: 36", 39", or 42" 	BC36	20.0	449
		BC39	20.0	490
		BC42	22.0	534

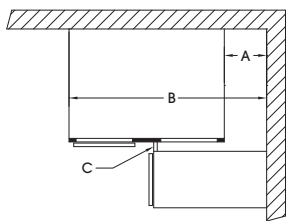

SKU	Cabinet Width	Blind Opening	Center Stile	A		B		C
				Minimum	Maximum	Minimum	Maximum	Minimum Filler width
BC36	27"	9"	6"	9 3/4"	13 1/2"	36 3/4"	40 1/2"	1"
BC39	30"	11 1/4"		7 1/2"	11 1/4"	39"	42 3/4"	
BC42	36"	13 1/2"		5 1/4"	9"	41 1/4"	45"	

A = Pull distance from wall
 B = Cabinet distance from wall
 C = Minimum filler width

Note: Blind openings are right side; door and drawer can be reversed during installation for left blind application.

Tall Cabinets – 21" and 24" Deep

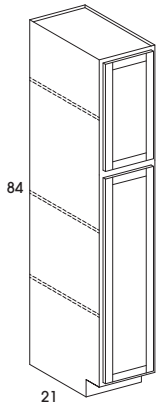
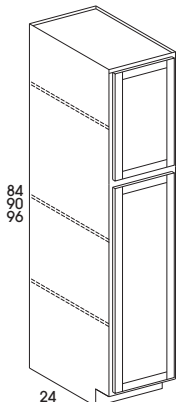
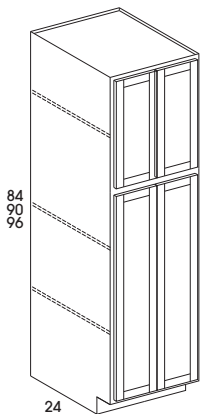
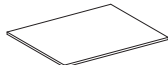
In Stock SKUs	SKU's	cubes	Sawyer Stain/Paint
LINEN CLOSET – 15" WIDE – 21" DEEP			
 <ul style="list-style-type: none"> • Two doors - hinged left • Doors can be reversed during installation for right hinge applications • Three adjustable shelves • Available height: 84" • Available width: 15" 	LC158421	16.0	789
UTILITY CABINET – 18" WIDE – 24" DEEP			
 <ul style="list-style-type: none"> • Two doors - hinged left • Doors can be reversed during installation for right hinge applications • Three adjustable shelves • Unfinished toekick is attached to all utility cabinets • Available width: 18" 	U188424	24.0	825
	U189024	26.0	877
	U189624	37.0	927
UTILITY CABINET – 24" WIDE – 24" DEEP			
 <ul style="list-style-type: none"> • Four doors (two sets of butt doors) • Three adjustable shelves • Unfinished toekick is attached to all utility cabinets • Available width: 24" 	U248424DD	32.0	1025
	U249024DD	34.0	1100
	U249624DD	39.0	1200
UTILITY CABINET SHELF			
 <ul style="list-style-type: none"> • SHELFKIT includes four shelves and clips • SHELF includes single shelf only, no clips • 1824 shelf: 22 3/16" x 16 3/16" • 2424 shelf: 22 3/16" x 22 3/16" 	U1824SHELFK	1.0	225
	U1824SHELF	1.0	95
	U2424SHELFK	1.0	335
	U2424SHELF	1.0	100

Tall Cabinets – 24" Deep

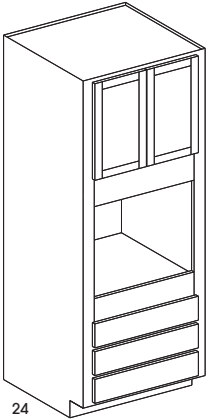
In Stock SKUs	SKU's	cubes	Sawyer Stain/Paint									
 <ul style="list-style-type: none"> • Two butt doors • No shelves included in upper cabinet • If desired order OCSHELF below • Inside opening is natural/white • Three bottom drawers • Two top drawers may be removed and cut to create a Double Oven opening • Oven cabinet has a 3" left and right stile running the entire height of the cabinet • Max cut out height = 33³/₄" • Max cut out width = 31" • Available width: 33" <table border="1" data-bbox="224 705 813 798"> <thead> <tr> <th colspan="3">Oven Cabinet</th> </tr> <tr> <th>SKU</th> <th>Oven Opening</th> <th>Upper Cabinet Opening</th> </tr> </thead> <tbody> <tr> <td>OC339624</td> <td>27" wide x 24" high</td> <td>27" wide x 30³/₄" high</td> </tr> </tbody> </table>	Oven Cabinet			SKU	Oven Opening	Upper Cabinet Opening	OC339624	27" wide x 24" high	27" wide x 30 ³ / ₄ " high	<p>OC339624</p>	<p>44.0</p>	<p>1838</p>
Oven Cabinet												
SKU	Oven Opening	Upper Cabinet Opening										
OC339624	27" wide x 24" high	27" wide x 30 ³ / ₄ " high										

Vanity Cabinets – 21" Deep

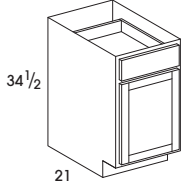
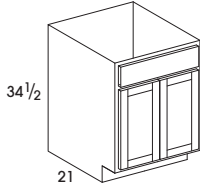
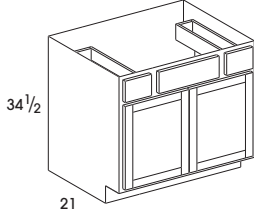
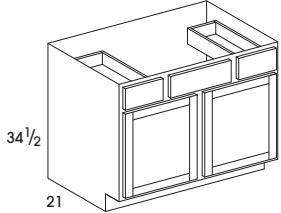
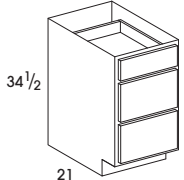
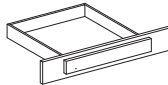
In Stock SKUs		SKU's	cubes	Sawyer Stain/Paint
VANITY BASE – 21" DEEP				
	<ul style="list-style-type: none"> • Single door - hinged left • Door can be reversed during installation for right hinge applications • One drawer • Available widths: 12"-18" 	VB12	6.0	348
		VB15	7.0	357
		VB18	8.0	363
VANITY SINK BASE – 21" DEEP				
	<ul style="list-style-type: none"> • Two butt doors • One false panel • Available widths: 24"-33" 	VSB24DD	10.0	415
		VSB27	12.0	426
		VSB30	13.0	431
		VSB33	14.0	442
VANITY SINK BASE WITH DRAWERS – 21" DEEP				
	<ul style="list-style-type: none"> • Two butt doors • Two drawers • One false panel • Available width: 36" 	VSDB36	15.0	525
	<ul style="list-style-type: none"> • Two doors with center mullion • Two drawers • One false panel • Available widths: 42" and 48" 	VSDB42	18.0	620
		VSDB48	20.0	660
VANITY DRAWER BASE – 21" DEEP				
	<ul style="list-style-type: none"> • Three drawers • Available widths: 12"-21" 	VDB12	6.0	453
		VDB15	7.0	457
		VDB18	8.0	465
		VDB21	9.0	502
UNDERMOUNT DRAWER – 21" DEEP				
	<ul style="list-style-type: none"> • 36" total width trimmable by 6" both sides • 24" drawer head 	VDT36	3.0	220

Accessories

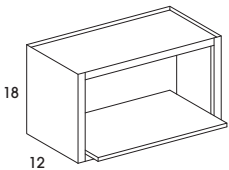
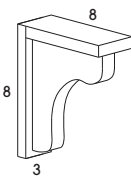
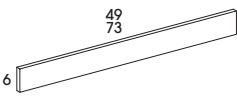
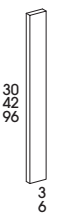
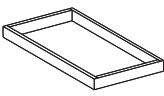
In Stock SKUs		SKU's	cubes	Sawyer Stain/Paint
MICROWAVE WALL CABINET				
	<ul style="list-style-type: none"> • Inside dimensions: 27" wide x 15" tall • Includes 14" deep, 1/2" thick plywood microwave shelf (installed within the opening; requires a spacer to level shelf) • Finished interior to match exterior • Available width: 30" 	MWC3018	4.0	395
BAR BRACKET				
	<ul style="list-style-type: none"> • 8" high x 8" deep 	BARBRACKET	1.0	100
STRAIGHT VALANCE				
	<ul style="list-style-type: none"> • 3/4" thick solid wood • Finished on front side only • Available widths: 49" and 73" 	V549ST	1.0	107
		V573ST	1.0	145
FILLER				
	<ul style="list-style-type: none"> • 3/4" thick solid wood • If you require an end to be exposed we suggest using a valance • Finished on the face, and two long sides; long sides receive a lesser finish • F330 and F630 may be used for either bases or 30" wall cabinets • Available widths: 3" and 6" 	F330	0.1	38
		WF342	0.1	55
		F396	0.1	105
		F630	0.2	66
		WF642	0.2	90
		F696	0.2	195
PULL-OUT SHELF FOR BASE AND TALL CABINETS				
	<ul style="list-style-type: none"> • POS - Epoxy side-mounted glides; 3/4" extension • Single drawer • Inside height - 1 1/2" • Overall height - 2 1/4" • Solid wood dovetail construction • Includes 5/8" thick dovetailed drawer • 75 lb. capacity per shelf • FIELD INSTALLED • Available widths: 12"-36" 	POS12 7 1/2" x 21"	1.0	100
		POS15 10 1/2" x 21"	1.0	110
		POS18 13 1/2" x 21"	1.0	120
		POS21 16 1/2" x 21"	1.0	130
		POS24 19 1/2" x 21"	1.0	140
		POS27 22 1/2" x 21"	1.0	150
		POS30 25 1/2" x 21"	1.0	160
		POS33 28 1/2" x 21"	1.0	170
		POS36 31 1/2" x 21"	1.0	180

Panels

In Stock SKUs	SKU's	cubes	Stain/Paint
PANELS			
<ul style="list-style-type: none"> • P4836V - Finished End Panel: 48" x 36" x 1/4" (grain runs with 36") - Plywood/vinyl 	P4836V	1.0	155
<ul style="list-style-type: none"> • P4896V - Finished End Panel: 48" x 96" x 1/4" (grain runs with 96") - Plywood/vinyl 	P4896V	1.0	330
<ul style="list-style-type: none"> • WSKIN - Finished Panel: 11 1/4" x 42" x 1/8" - Plywood/vinyl 	WSKIN	0.1	70
<ul style="list-style-type: none"> • BSKIN - Finished Panel: 23 1/4" x 34 1/2" x 1/8" - Plywood/vinyl 	BSKIN	0.1	90
<ul style="list-style-type: none"> • REFP24 - Finished Refrigerator Panel: 23 13/16" x 96" with 1 1/2" stile - 3/8" Furniture board/vinyl 	REFP24	1.0	250
<ul style="list-style-type: none"> • 3/4REFP24 - Finished Refrigerator Panel: 24" x 3/4" x 96", Edge banded - one long side) - Plywood/vinyl 	3/4REFP24	1.0	515
<ul style="list-style-type: none"> • DWP3 - Dishwasher End Panel with 3" stile - 3/8" Furniture board/vinyl 	DWP3	1.0	125

Mouldings

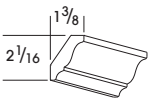
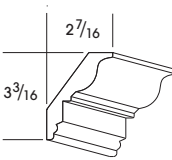
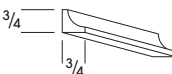
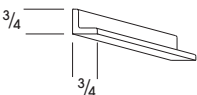
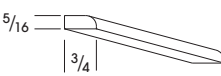
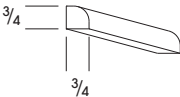
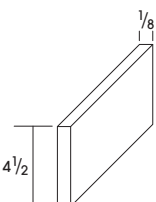
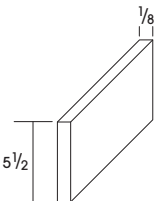
In Stock SKUs	SKU's	cubes	Stain/Paint	
SMALL CROWN				
	<ul style="list-style-type: none"> • 8 Feet Long • Crown moulding • Available in all colors 	SMCROWN214	1.0	85
LARGE CROWN				
	<ul style="list-style-type: none"> • 8 Feet Long • Crown moulding • Available in all colors 	LGCROWN4	1.0	125
INSIDE CORNER MOULDING				
	<ul style="list-style-type: none"> • 8 Feet Long • Inside corner • Available in all colors 	MICW	1.0	52
OUTSIDE CORNER MOULDING				
	<ul style="list-style-type: none"> • 8 Feet Long • Outside corner • Available in all colors 	MOCW	1.0	55
SCRIBE MOULDING				
	<ul style="list-style-type: none"> • 8 Feet Long • Scribe • Available in all colors 	MSW	1.0	39
QUARTER ROUND MOULDING				
	<ul style="list-style-type: none"> • 8 Feet Long • Quarter Round • Available in all colors 	MQR	1.0	52
TOEKICK MOULDING				
	<ul style="list-style-type: none"> • 8 Feet Long • 4 1/2" Toekick • Available in all colors 	TOEKICK	1.0	22
	<ul style="list-style-type: none"> • 8 Feet Long • 5 1/2" Toekick • Available in all colors 	TOEKICKUD	1.0	25

Hardware & Parts

		Description	List
BIFDOORHINGE	1412981	Attaches door to cabinet frame	40
BIFDOORPLATE	1412982	Attaches door to cabinet frame	8
BIFPIANOHINGE	1412983	Attaches door to door	55
BIFPIANOPLATE	1412984	Attaches door to door	3
BUMPERPAD	1236889	Bumper pads 72/sheet (clear)	10
FALSEFRONTCLIPS	1231138	Attachment clips for false drawer fronts (common on Vanity and sink bases)	.80
ROLLERS	1231139	Roller clip to couple with false panel clips. Snaps into it.	1
HINGE6G	1915285	Replacement self-closing hinge (Does not have Integrated Soft Close)	8.92
SCREWS	1231140	Glide screws (drawer box or cabinet member)	.15
SHCLIP	1206859	Shelf clip 0.2 (sold individually)	.75
POSHARDWARE	1231129	2 spacers & 6 screws for POS kits. Included in POS, replacement item	8.92
POSGLIDEG	1915539	Set of glides for POS (rear socket sold separately)	58
POSSOCKETLG	1915370	POS socket only—left	8.92
POSSOCKETRG	1915387	POS socket only—right	8.92
VCGLIDEG	1915336	Non Soft Close Vanity cabinet glide (rear socket & plugs attached) - Set	33
BCGLIDEG	1915251	Non Soft Close Base cabinet glide (rear socket & plugs attached) - Set	32
CGUNIVSOCKETG	2773946	Universal cabinet glide socket. Can be used on base and vanity base	2

List price is each unless otherwise noted in the description.

FINISH	IN STOCK						SPECIAL ORDER					
	TOUCH-UP KITS	LIST EACH	STAIN & PAINT	LIST PINT	SPRAY	LIST 12 OZ. CAN (NO PRIMER)	TOUCH-UP MARKER	LIST	FILL STICK	LIST	PUTTY	LIST
PEWTER PAINT	3113189	73	3113208	97	3113209	84	3795567	122	3795586	55	3543787	50
WHITE PAINT	1207236	73	1236980	97	1418160	84	3795563	122	3795582	55	3543785	50
DARK SABLE	1414298	73	1414291	77	—	—	3795564	91	3795583	55	3543785	50
GREY STAIN	2870437	73	2870432	77	—	—	3795568	91	3795587	55	3543786	50
TOP COAT	—	—	1414350	121 (QUART)	1915465	123 12 OZ CAN	—	—	—	—	—	—

Special order Touch-up Markers and Fill sticks will be shipped direct.

Touch-up kits include 1 putty fill stick, 1 touch-up marker and 1 small bottle of top coat

Wolf pints of stain and paint are for touch up purposes only. When doing a color match for a larger project we recommend taking a door to a professional paint store to do a color match.

Wall Cabinets – 12" and 15" Deep

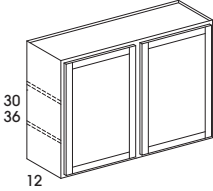
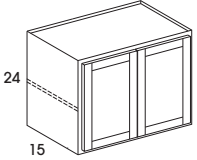
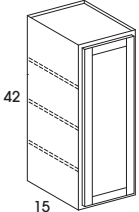
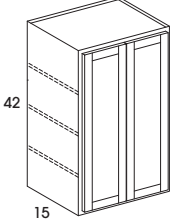
Special Order SKUs – Available with extended lead time		SKU's	cubes	Sawyer Stain/Paint
WALL – 12" DEEP				
 <ul style="list-style-type: none"> • Two doors with center mullion • Two adjustable shelves • Available width: 48" 	W4830	10.0	525	
	W4836	12.0	538	
WALL – 15" DEEP				
 <ul style="list-style-type: none"> • Two butt doors • One adjustable shelf • Available width: 36" 	W362415	9.0	500	
	 <ul style="list-style-type: none"> • Single door - hinged left • Cabinet can be flipped during installation for right hinge applications • Three adjustable shelves • Available widths: 15" and 18" 			
		W154215	8.0	375
		W184215	7.0	440
 <ul style="list-style-type: none"> • Two butt doors • Three adjustable shelves • Available width: 24" 	W244215DD	9.0	515	
			W304215	11.0

Wall Cabinets – 12", 15" and 24" Deep

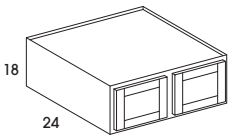
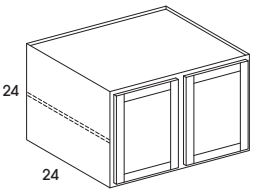
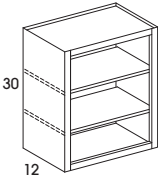
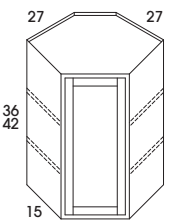
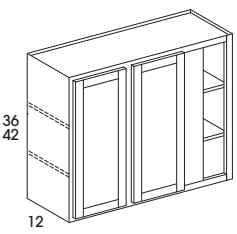
Special Order SKUs – Available with extended lead time		SKU's	cubes	Sawyer Stain/Paint
REFRIGERATOR WALL - 24" DEEP				
 <p>18 24</p>	<ul style="list-style-type: none"> • Two doors with center mullion • Shelves not available • Available heights: 12" and 18" • Available width: 39" 	RW3912	7.0	408
		RW3918	10.0	495
 <p>24 24</p>	<ul style="list-style-type: none"> • Two doors with center mullion • One adjustable shelf • Available height: 24" • Available width: 39" 	RW3924	13.0	510
BOOKCASE CABINET - 30" HIGH - 12" DEEP				
 <p>30 12</p>	<ul style="list-style-type: none"> • No door • Matching Interior • Two adjustable shelves • Available width: 21" 	BK2130	6.0	470
WALL CORNER - DIAGONAL				
 <p>27 36 42 15</p>	<ul style="list-style-type: none"> • Single door - hinged left • Cabinet can be flipped during installation for right hinge applications • 36" has two adjustable shelves • 42" has three adjustable shelves • Available width: 27" 	WDC2736	15.0	647
		WDC2742	16.0	768
WALL CORNER - BLIND - 12" DEEP				
 <p>36 42 12</p>	<ul style="list-style-type: none"> • Two doors with center mullion • 36" has two adjustable shelves • 42" has three adjustable shelves • Blind cabinets can be pulled 3" • Blind opening is 7" on all sizes • Does not include a panel to cover blind opening • Filler required; order separately • Available widths: 42" 	WC4236	12.0	513
		WC4242	12.0	559

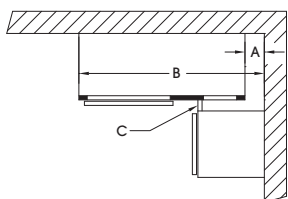

SKU	Cabinet Width	Blind Opening	Center Stile	A		B		C
				Minimum	Maximum	Minimum	Maximum	Minimum Filler width
WC42_ _	42"	7"	6"	0"	3 1/2"	42"	45 1/2"	N/A

A = Pull distance from wall
 B = Cabinet distance from wall
 C = Minimum filler width

Note: Blind openings are right side; cabinet will be flipped during installation for left blind applications.

Sink Fronts / Base Corner

Special Order SKUs - Available with extended lead time

SKU's

cubes

Sawyer Stain/Paint

SINK/RANGE FRONT STRAIGHT

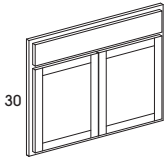

- Trimmable by 3"
- Face frame with doors and drawer front only
- Available widths: 30" and 36"

SF30FF

4.0

320

SF36FF

5.0

350

SINK/RANGE FRONT DIAGONAL

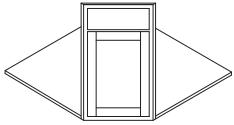

- Single door - hinged left
- Door can be reversed during installation for right hinge applications
- One false panel
- Face frame and floor only
- Floor space: 36" x 36" or 42" x 42"

SCB36FF

2.0

342

SCB42FF

3.0

375

BASE CORNER - 34 1/2" HIGH - 24" DEEP

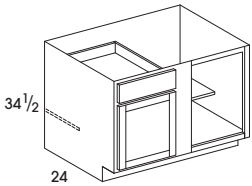

- Single door - hinged left
- Door can be reversed during installation for right hinge applications
- One drawer
- One adjustable half-depth shelf
- Does not include a panel to cover blind opening
- Filler required; order separately
- Available width: 45"

BC45

22.0

544

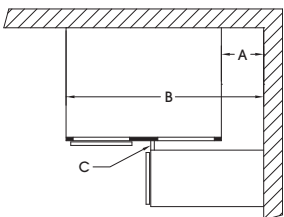

SKU	Cabinet Width	Blind Opening	Center Stile	A		B		C
				Minimum	Maximum	Minimum	Maximum	Minimum Filler width
BC45	42"	16 1/2"	6"	2 1/4"	6"	44 1/4"	48"	1"

A = Pull distance from wall
 B = Cabinet distance from wall
 C = Minimum filler width

Note: Blind openings are on the right side; Door and drawer can be reversed during installation for left blind applications.

Tall Cabinets / Oven Cabinet

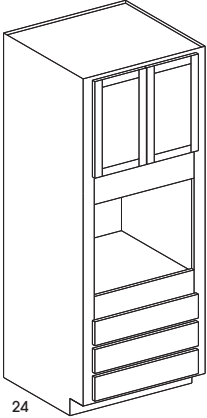
Special Order SKUs – Available with extended lead time	SKU's	cubes	Sawyer Stain/Paint												
OVEN CABINET – 33" WIDE – 24" DEEP															
 <ul style="list-style-type: none"> • Two butt doors • No shelves included in upper cabinet • If desired order OCSHELF below • Inside opening is natural/white • Three bottom drawers • Two top drawers may be removed and cut to create a Double Oven opening • Oven cabinet has a 3" left and right stile running the entire height of the cabinet • Max cut out height = 33³/₄" • Max cut out width = 31" • Available width: 33" <table border="1" data-bbox="224 745 813 865"> <thead> <tr> <th colspan="3">Oven Cabinet</th> </tr> <tr> <th>SKU</th> <th>Oven Opening</th> <th>Upper Cabinet Opening</th> </tr> </thead> <tbody> <tr> <td>OC338424</td> <td>27" wide x 24" high</td> <td>27" wide x 18³/₄" high</td> </tr> <tr> <td>OC339024</td> <td>27" wide x 24" high</td> <td>27" wide x 24³/₄" high</td> </tr> </tbody> </table>	Oven Cabinet			SKU	Oven Opening	Upper Cabinet Opening	OC338424	27" wide x 24" high	27" wide x 18 ³ / ₄ " high	OC339024	27" wide x 24" high	27" wide x 24 ³ / ₄ " high	OC338424	39.0	1583
Oven Cabinet															
SKU	Oven Opening	Upper Cabinet Opening													
OC338424	27" wide x 24" high	27" wide x 18 ³ / ₄ " high													
OC339024	27" wide x 24" high	27" wide x 24 ³ / ₄ " high													
	OC339024	42.0	1715												

Door Panels / Decorative End Panels

Special Order SKUs – Available with extended lead time	SKU's	cubes	Sawyer Stain/Paint
DOOR PANELS (ACTUAL DOORS)			
<ul style="list-style-type: none"> • DWEP30 - Decorative End Panel for 30" Wall Cabinet: 11" x 28" x 3/4" 	DWEP30	0.1	159
<ul style="list-style-type: none"> • DWEP36 - Decorative End Panel for 36" Wall Cabinet: 11" x 34" x 3/4" 	DWEP36	0.1	159
<ul style="list-style-type: none"> • DWEP42 - Decorative End Panel for 42" Wall Cabinet: 11" x 40" x 3/4" 	DWEP42	0.1	191
<ul style="list-style-type: none"> • DEPVB - Decorative End Panel for Vanity Base: 19" x 28" x 3/4" 	DEPVB	0.1	200
<ul style="list-style-type: none"> • DEPB - Decorative End Panel Base Cabinet: 22" x 28" x 3/4" 	DEPB	0.1	200
DECORATIVE END PANELS – TALL CABINET (ACTUAL DOORS)			
<ul style="list-style-type: none"> • DEPTB - Bottom section for all Tall cabinet 	DEPTB	0.1	310
<ul style="list-style-type: none"> • DEPT84 - Top section for 84" Tall cabinet 	DEPT84	0.1	408
<ul style="list-style-type: none"> • DEPT90 - Top section for 90" Tall cabinet 	DEPT90	0.1	471
<ul style="list-style-type: none"> • DEPT96 - Top section for 96" Tall cabinet 	DEPT96	0.1	534

Universal Design Specifications

What is ADA Compliance vs. Universal Design?

ADA compliant cabinets are designed to meet the needs of people with disabilities per the Americans with Disabilities Act. Builders Mark Cabinets offers a reduced height product that may be used in your ADA or UD design. Although product choice does need to be considered, designing for ADA and UD is not just about product, it's mainly about design principles and building codes. For more information about ADA regulations, please visit www.ADA.gov.

ADA compliance is based on the overall height of the workspace, clear floor space, knee clearance and toe clearance combined. All of these elements must be applied together and accurately for your design to be considered ADA compliant. Codes will vary and it is important for you to understand your local codes before starting your design.

Universal Design, also known as Aging in Place Design, is a much broader concept. The goal is to create an environment that is usable, to the greatest extent possible, by people of any age or ability without the need for a special design or adaptation. In order to be considered UD, your design must consider the space needed for approach, reach, manipulation and overall use regardless of the user's body size, posture or mobility.

Universal Design Builders Mark cabinets are 32½" in height and have a 5½" toekick.

All other product specifications are the same as our standard cabinet.

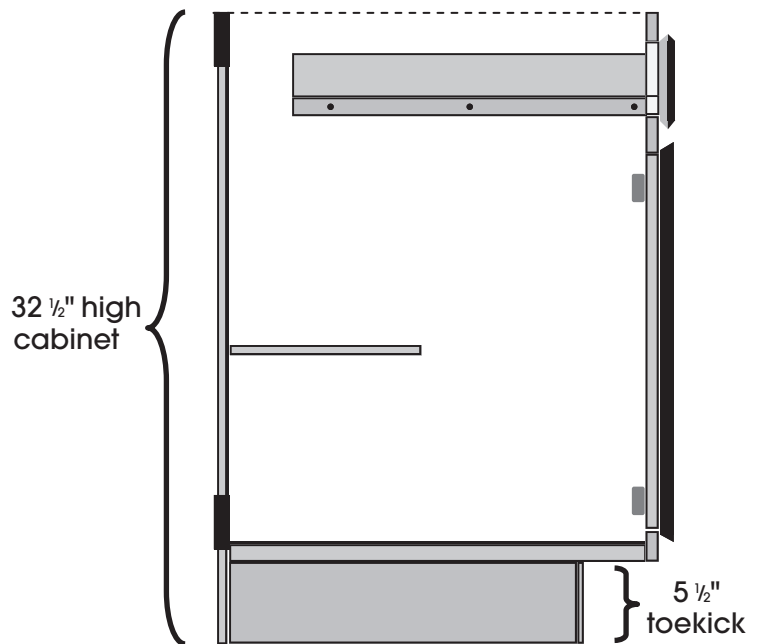

Universal Design Cabinets – 24" Deep

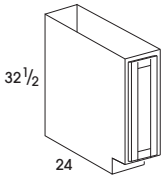
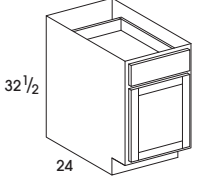
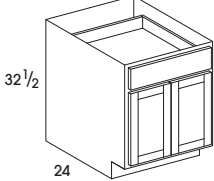
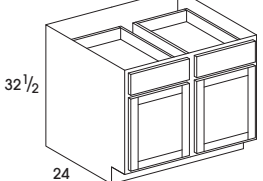
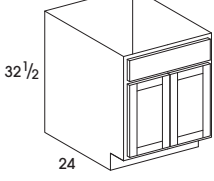
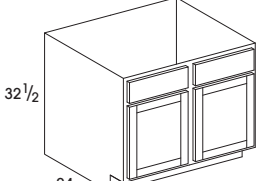
Special Order SKUs – Available with extended lead time		SKU's	cubes	Sawyer Stain/Paint
BASE – 32½" HIGH – 24" DEEP				
	<ul style="list-style-type: none"> • Single full-height door - hinged left • Door can be reversed during installation for right hinge applications • Shelves not available • UD Bases do not include an interior shelf due to the height and depth of the toekick • Available width: 9" 	B09FHUD	6.0	345
	<ul style="list-style-type: none"> • Single door - hinged left • Door can be reversed during installation for right hinge applications • One drawer • Shelves not available • UD Bases do not include an interior shelf due to the height and depth of the toekick • Available widths: 12"-21" 	B12UD	7.0	373
		B15UD	9.0	394
		B18UD	10.0	430
		B21UD	12.0	460
	<ul style="list-style-type: none"> • Two butt doors • One drawer • Shelves not available • UD Bases do not include an interior shelf due to the height and depth of the toekick • Available widths: 24"-36" 	B24DDUD	13.0	516
		B27UD	15.0	520
		B30UD	17.0	540
		B33UD	18.0	550
		B36UD	20.0	575
	<ul style="list-style-type: none"> • Two doors with center mullion • Two drawers • Shelves not available • UD Bases do not include an interior shelf due to the height and depth of the toekick • Available widths: 39" and 42" 	B39UD	21.0	655
		B42UD	23.0	740
SINK BASE – 32½" HIGH – 24" DEEP				
	<ul style="list-style-type: none"> • Two butt doors • One false panel • Available widths: 24"-36" 	SB24DDUD	14.0	438
		SB27UD	16.0	448
		SB30UD	17.0	485
		SB33UD	19.0	500
		SB36UD	20.0	530
	<ul style="list-style-type: none"> • Two doors with center mullion • Two false panels • Available widths: 39" and 42" 	SB39UD	22.0	545
		SB42UD	23.0	565

Universal Design Cabinets – 24" Deep

Special Order SKUs – Available with extended lead time	SKU's	cubes	Sawyer Stain/Paint
--	-------	-------	--------------------

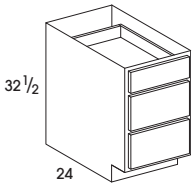
THREE DRAWER BASE – 32½" HIGH – 24" DEEP			
 <ul style="list-style-type: none"> • Three drawers • Available widths: 12"-36" 	DB12UD	7.0	510
	DB15UD	9.0	535
	DB18UD	10.0	575
	DB21UD	12.0	600
	DB24UD	13.0	635
	DB30UD	17.0	680
	DB36UD	20.0	740

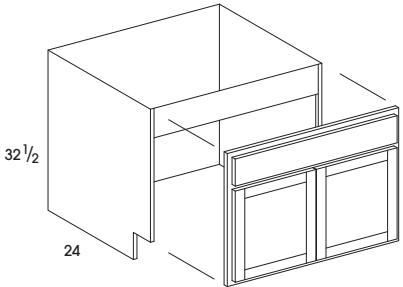
REMOVABLE FRONT CABINETS – 32½" HIGH – 24" DEEP			
 <ul style="list-style-type: none"> • Includes both pieces • Interior finish: natural on stained products/white on painted products • Removable fronts are attached to the face frame using barrel catch hardware • Includes removable floor • Available widths" 30"-36" 	SB30REMUD	20.0	1100
	SB33REMUD	22.0	1150
	SB36REMUD	23.0	1210

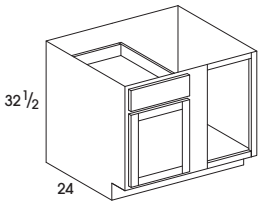
BASE CORNER – 32½" HIGH – 24" DEEP			
 <ul style="list-style-type: none"> • Single door - hinged left • Door can be reversed during installation for right hinge applications • One drawer • Shelves not available • UD Bases do not include an interior shelf due to the height and depth of the toekick • Does not include a panel to cover blind opening • Filler required; order separately • Available widths: 36", 39", or 42" 	BC36UD	20.0	471
	BC39UD	20.0	516
	BC42UD	22.0	561

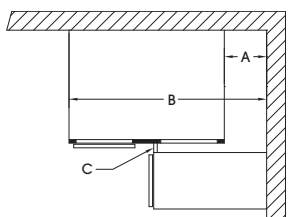

SKU	Cabinet Width	Blind Opening	Center Stile	A		B		C
				Minimum	Maximum	Minimum	Maximum	Minimum Filler width
BC36UD	27"	9"	6"	9¾"	13½"	36¾"	40½"	1"
BC39UD	30"	11¼"		7½"	11¼"	39"	42¾"	
BC42UD	36"	13½"		5¼"	9"	41¼"	45"	

A = Pull distance from wall
 B = Cabinet distance from wall
 C = Minimum filler width

Note: Blind openings are right side; door and drawer can be reversed during installation for left blind application.

Universal Design Cabinets – 21" Deep

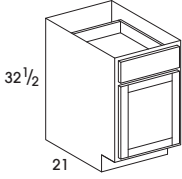
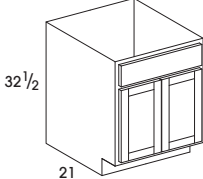
Special Order SKUs – Available with extended lead time		SKU's	cubes	Sawyer Stain/Paint
VANITY BASE – 32½" HIGH – 21" DEEP				
 <p>32½ 21</p>	<ul style="list-style-type: none"> • Single door - hinged left • Door can be reversed during installation for right hinge applications • One drawer • Available widths: 12"-18" 	VB12UD	6.0	395
		VB15UD	7.0	405
		VB18UD	8.0	415
VANITY SINK BASE – 32½" HIGH – 21" DEEP				
 <p>32½ 21</p>	<ul style="list-style-type: none"> • Two butt doors • One false panel • Available widths: 24"-33" 	VSB24DDUD	10.0	476
		VSB27UD	12.0	448
		VSB30UD	13.0	454
		VSB33UD	14.0	475

Universal Design Cabinets – 21" Deep

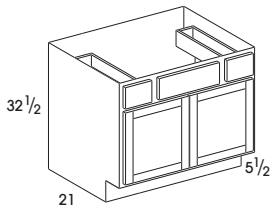
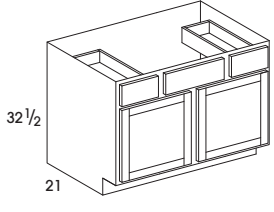
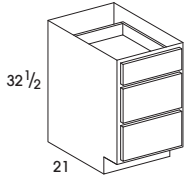
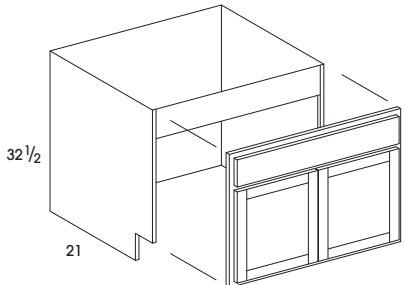
Special Order SKUs – Available with extended lead time		SKU's	cubes	Sawyer Stain/Paint
VANITY SINK BASE WITH DRAWERS – 32½" HIGH – 21" DEEP				
	<ul style="list-style-type: none"> • Two butt doors • Two drawers • One false panel • UD Bases do not include an interior shelf due to the height and depth of the toekick • Available width: 36" 	VSDB36UD	15.0	600
		VANITY SINK BASE WITH DOORS – 32½" HIGH – 21" DEEP		
	<ul style="list-style-type: none"> • Two doors with center mullion • Two drawers • One false panel • Shelves not available • UD Bases do not include an interior shelf due to the height and depth of the toekick • Available widths: 42" and 48" 	VSDB42UD	18.0	680
		VSDB48UD	20.0	720
VANITY THREE DRAWER BASE – 32½" HIGH – 21" DEEP				
	<ul style="list-style-type: none"> • Three drawers • Available widths: 12-21" 	VDB12UD	6.0	474
		VDB15UD	7.0	480
		VDB18UD	8.0	488
		VDB21UD	9.0	526
REMOVABLE FRONT CABINETS – 32½" HIGH – 21" DEEP				
	<ul style="list-style-type: none"> • Includes both pieces • Interior finish: natural on stained products/white on painted products • Removable fronts are attached to the face frame using barrel catch hardware • Includes removable floor • Available widths: 30" and 36" 	VSB30REMUD	16.0	1030
		VSB36REMUD	18.0	1130

Builders Mark Tempo Cabinets from Wolf Home Products have been manufactured under the highest standards of quality and workmanship.

2-Year Limited Warranty

Wolf Home Products warrants that its cabinets and related components ("Products") will be free of all defects in materials and workmanship for two (2) years from date of purchase under normal use subject to the exclusions contained herein.

Warrantor's obligation here under is valid only for the standard application in which the Products are used when properly installed in accordance with applicable building codes, conditions, industry acceptable standards and Warrantor's installation instructions. This warranty is not valid for Products used for any purpose other than the purpose for which it was originally intended. Warrantor shall not be responsible for any losses sustained or costs incurred that are reported after the expiration of the two (2) year warranty period.

Warrantor's sole responsibility, and the buyer's sole and exclusive remedy, shall be the refund or replacement, at no additional charge to buyer, or the defective Product. Warrantor shall not be responsible for any consequential damages, lost profits, or any other costs or damages all of which are specifically excluded, including without limitation labor, installation, shipping, transport, disposal, or any costs associated with the Product including without limitation plumbing, walls, flooring, fixtures, gas or electric appliances, or countertops, all of which are specifically excluded.

This warranty does not cover claims arising out of natural characteristics of some wood to split, warp or twist, or natural variations in grain, mineral streaks, knots and color.

This warranty does not cover claims arising out of misuse, physical abuse, alteration, accident, improper care in performing necessary upkeep after installation, acts of God, acts of war, vermin or insect infestation, or other chemical or biological factors.

Failure to follow written instructions, restrictions or warnings supplied with the Product shall make the Warrantor's obligation hereunder null and void and of no further effect.

THIS WARRANTY IS THE EXCLUSIVE WARRANTY OF WOLF HOME PRODUCTS AND IS IN LIEU OF AND WOLF HOME PRODUCTS DISCLAIMS ALL OTHER WARRANTIES, EXPRESS OR IMPLIED, INCLUDING IMPLIED WARRANTIES OF MERCHANTABILITY AND FITNESS FOR A PARTICULAR PURPOSE. Some states do not allow the exclusion or limitation of incidental or consequential damages, so the above limitations or exclusions may not apply to you. This warranty gives you specific legal rights, and you may also have other rights which vary from state to state.

To submit a claim under this warranty, contact your Builders Mark Tempo cabinets dealer or send a letter explaining the defect along with photo and a dated sales receipt as proof of purchase to the address below.

Builders Mark Cabinets
Attn: Warranty Claims
20 West Market Street
York, PA 17401
phone 800-234-9653
wolfhomproducts.com





TRANSFORMING
HOMES FOR

180

— YEARS —

Wolf Home Products® is an innovator in the building products industry. Transforming homes for 180 years, Wolf Home Products has been the preferred home building products brand by families across North America who value the importance of their home and time together to build lasting memories in the spaces they enjoy most. With a vast inventory of kitchen and bath, outdoor living and building products, Wolf Home Products delivers orders in a fraction of the time, ensuring unparalleled value when and where customers need it. Wolf stands behind its service, cultivated with years of business experience into a total satisfaction guarantee.



Find us on Instagram @[wolfhomeproducts](https://www.instagram.com/wolfhomeproducts) for inspiration on your next project!



Kitchen & Bath



Outdoor Living



Building Products

[wolfhomeproducts.com](https://www.wolfhomeproducts.com) | © 2023 Wolf Home Products. All Rights Reserved.

All photos and colors are representative of product. Please review an actual product sample with your dealer before making your final selection. A contract is formed only after receipt of Wolf's written order confirmation. Information contained within is subject to change without notice. Not all products available in every market.